

Seghe radiali

Radial arm saws / Scies radiales / Sierras radiales

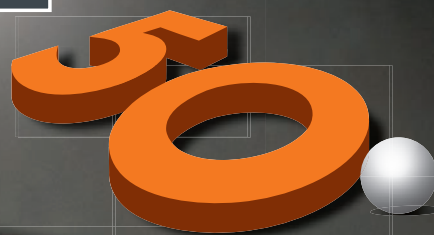

ANNIVERSARY
1963 - 2013

Junior 640 / Big 800

CE

EC VERSION

Best 960 / Best1250

CE

EC VERSION



Dettagli Details/Détails/Detailles

Junior 640 / Big 800 / Best 960 / Best 1250

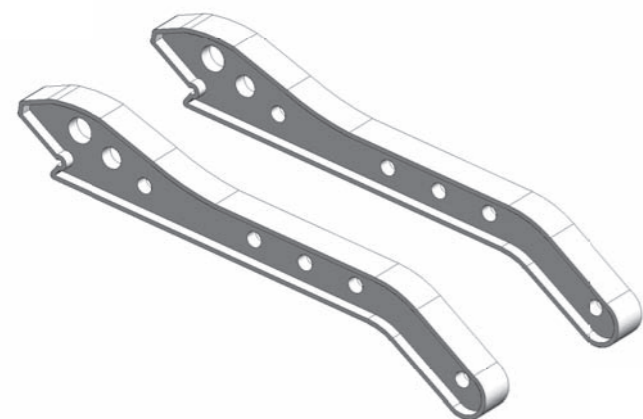
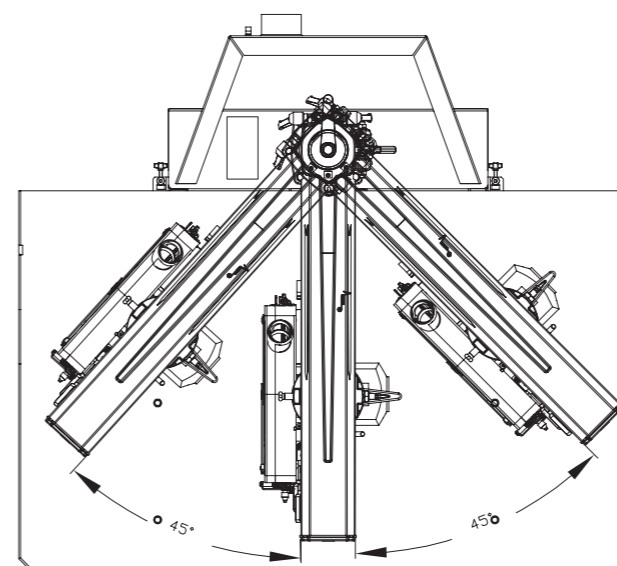

00005118 Spingilegno / Push stick / Pousse-bois / Empujador

Optional

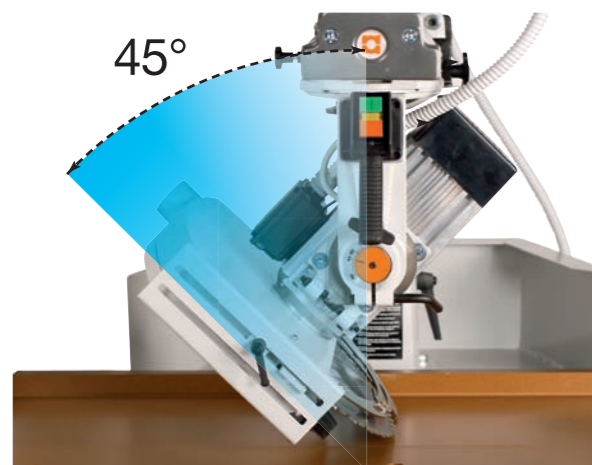

Best 960/Best 1250



Ø 400 mm

00015104

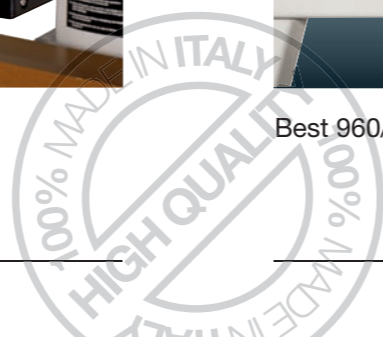

Best 700 S Best 960 S / Best 1250 S



EG VERSION



Dettagli

Details/Détails/Detailles

Best 700 S / Best 960 S / Best 1250 S

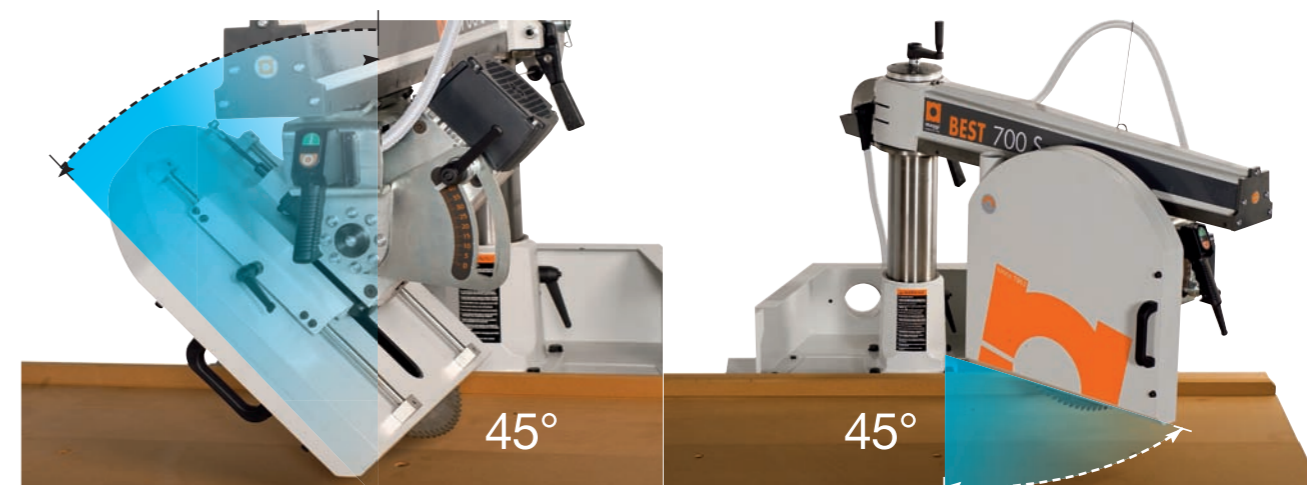

25404002 Best 700 S / 960 S / 1250 S

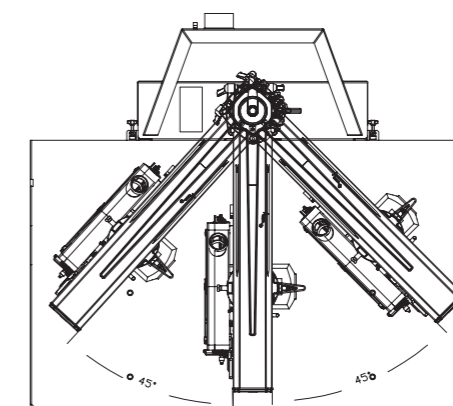

Optional



25686100 Best 700 S
25673100 Best 960 S



Best 700 S



00015101 Ø 565 mm



Capacità di taglio

Cutting diagram/Capacité de coupe/Capacidad de corte



LUNGHEZZA / LENGTH / LONGUEUR / LARGO

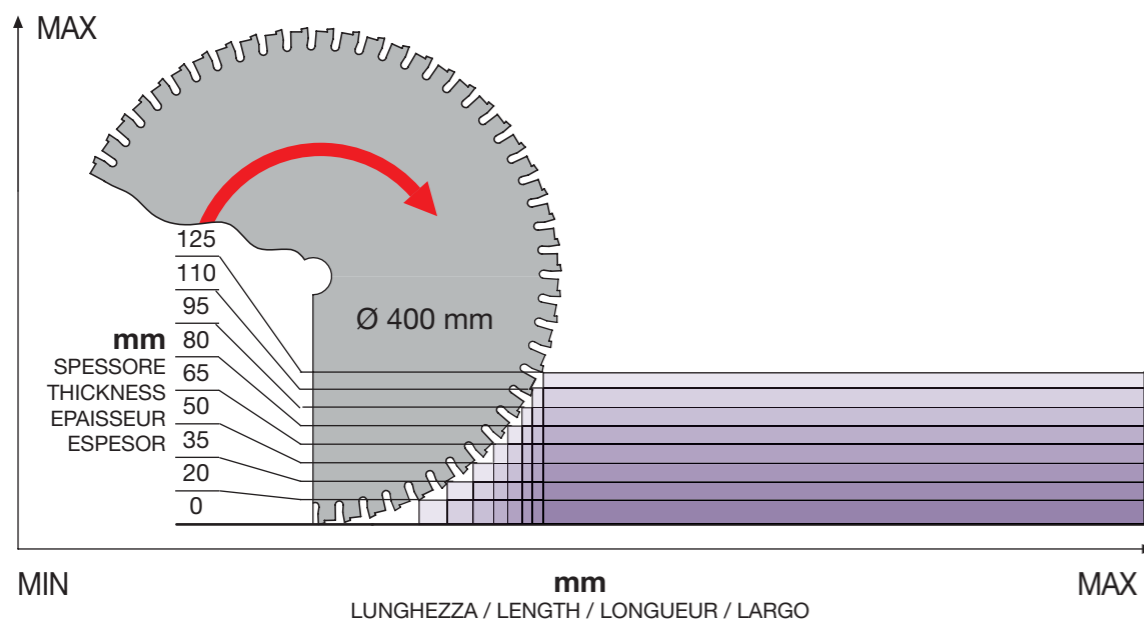

Junior 640			Big 800			Best 960			Best 1250		
90°	45° SX	45° DX	90°	45° SX	45° DX	90°	45° SX	45° DX	90°	45° SX	45° DX
mm	mm	mm	mm	mm	mm	mm	mm	mm	mm	mm	mm
450	125	315	610	240	430	770	350	565	1060	555	745
456			616			776			1066		
464			624			784			1074		
474			634			794			1084		
486			646			806			1096		
501			661			821			1111		
520			680			840			1130		
545	190	380	705	310	500	865	425	615	1155	610	800

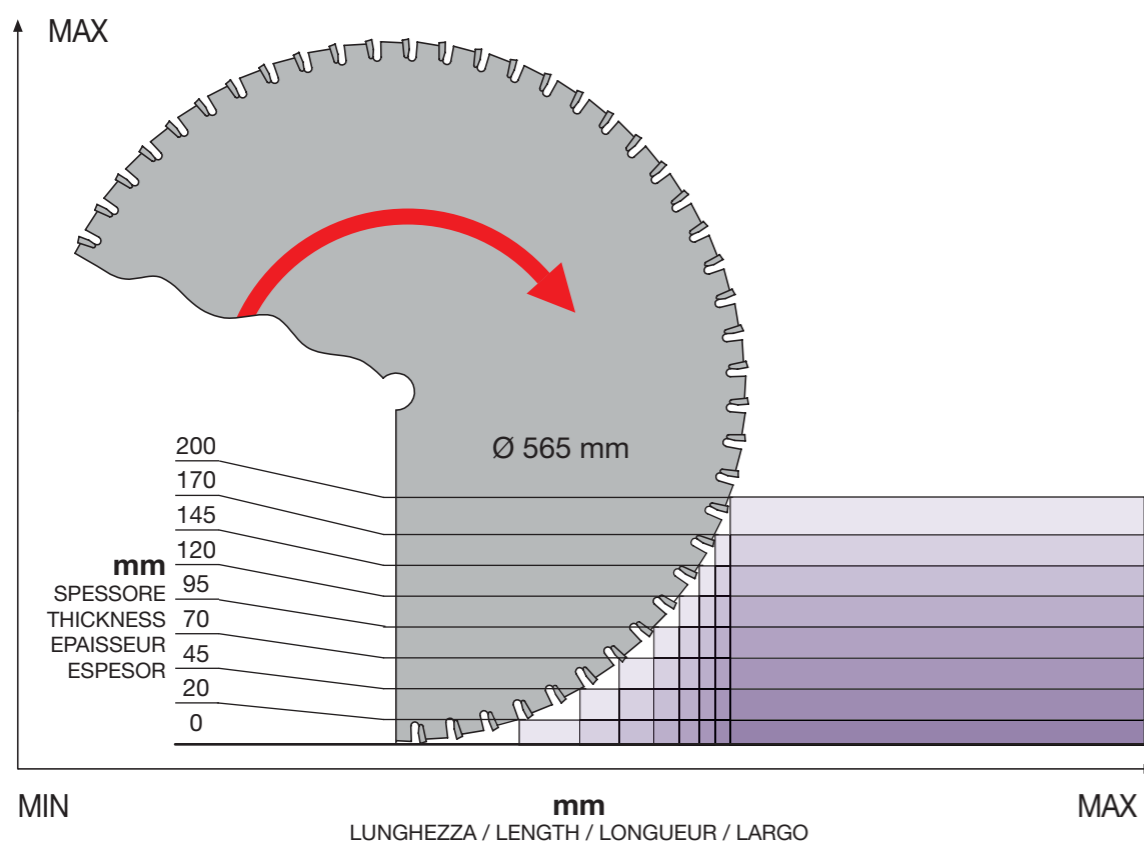

LUNGHEZZA / LENGTH / LONGUEUR / LARGO

Best 700 S			Best 960 S			Best 1250 S					
90°	45° SX	45° DX	90°	45° SX	45° DX	90°	45° SX	445° DX			
mm	mm	mm	mm	mm	mm	mm	mm	mm			
400	80	270	680	280	470	970	385	675			
411			691			981					
424			704			994					
440			720			1010					
460			740			1030					
486			766			1056					
520			800			1090					
570	210	400	850	400	590	1140	595	785			

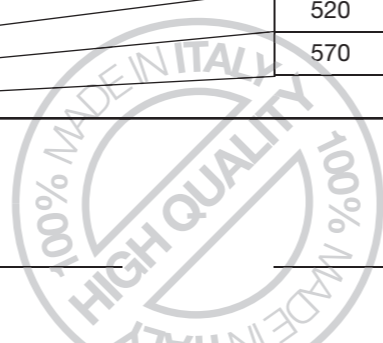

EC VERSION

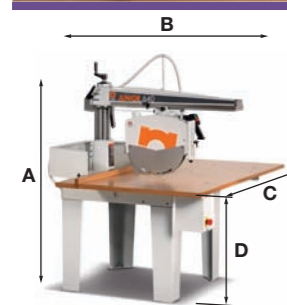
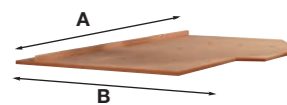
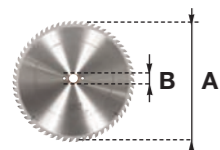

	Junior 640	Big 800	Best 960	Best 1250	Best 700 S	Best 960 S	Best 1250 S
	A Ø 400 mm B Ø 30 mm	A Ø 400 mm B Ø 30 mm	A Ø 400 mm B Ø 30 mm	A Ø 400 mm B Ø 30 mm	A Ø 565 mm B Ø 30 mm	A Ø 565 mm B Ø 30 mm	A Ø 565 mm B Ø 30 mm
	HP 4 kW 3 3PH 2800 RPM	HP 4 kW 3 3PH 2800 RPM	HP 4 kW 3 3PH 2800 RPM	HP 4 kW 3 3PH 2800 RPM	HP 7,5 kW 5,5 3PH 2800 RPM	HP 7,5 kW 5,5 3PH 2800 RPM	HP 7,5 kW 5,5 3PH 2800 RPM
	Ø 60 mm	Ø 60 mm	Ø 60 mm	Ø 60 mm	Ø 60 mm	Ø 60 mm	Ø 60 mm
	Ø 100 mm	Ø 100 mm	Ø 100 mm	Ø 100 mm	Ø 100 mm	Ø 100 mm	Ø 100 mm
	A 1580 mm B 975 mm	A 1860 mm B 1145 mm	A 2000 mm B 1355 mm	A 2400 mm B 1580 mm	A 1700 mm B 1095 mm	A 2000 mm B 1355 mm	A 2400 mm B 1580 mm
	0 - 860 mm	0 - 1030 mm	0 - 1150 mm	0 - 1440 mm			
	0 - 45 mm	0 - 45 mm	0-150 mm	0-150 mm	0 - 70 mm	0 - 70 mm	0 - 70 mm
	0 - 80 mm	0 - 80 mm	0 - 80 mm	0 - 80 mm	0 - 135 mm	0 - 135 mm	0 - 135 mm
	A 1550 mm B 1400 mm C 1580 mm D 800 mm	A 1550 mm B 1570 mm C 1860 mm D 800 mm	A 1680 mm B 1820 mm C 2000 mm D 800 mm	A 1680 mm B 1940 mm C 2400 mm D 800 mm	A 1680 mm B 1560 mm C 1700 mm D 800 mm	A 1680 mm B 1820 mm C 2000 mm D 800 mm	A 1680 mm B 1940 mm C 2400 mm D 800 mm
	1600 x 850 x 660 mm 203 kg 215 kg	1900 x 850 x 660 mm 225 kg 237 kg	2000 x 1000 x 670 mm 294 kg 306 kg	2400 x 1050 x 700 mm 344 kg 362 kg	1700 x 1000 x 1200 mm 298 kg 310 kg	2000 x 1000 x 1200 mm 311 kg 326 kg	2400 x 1050 x 1230 mm 364 kg 382 kg

Junior 640 standard Big 800 standard

STANDARD VERSION

Best 960 standard Best 1250 standard

STANDARD VERSION



Capacità di taglio



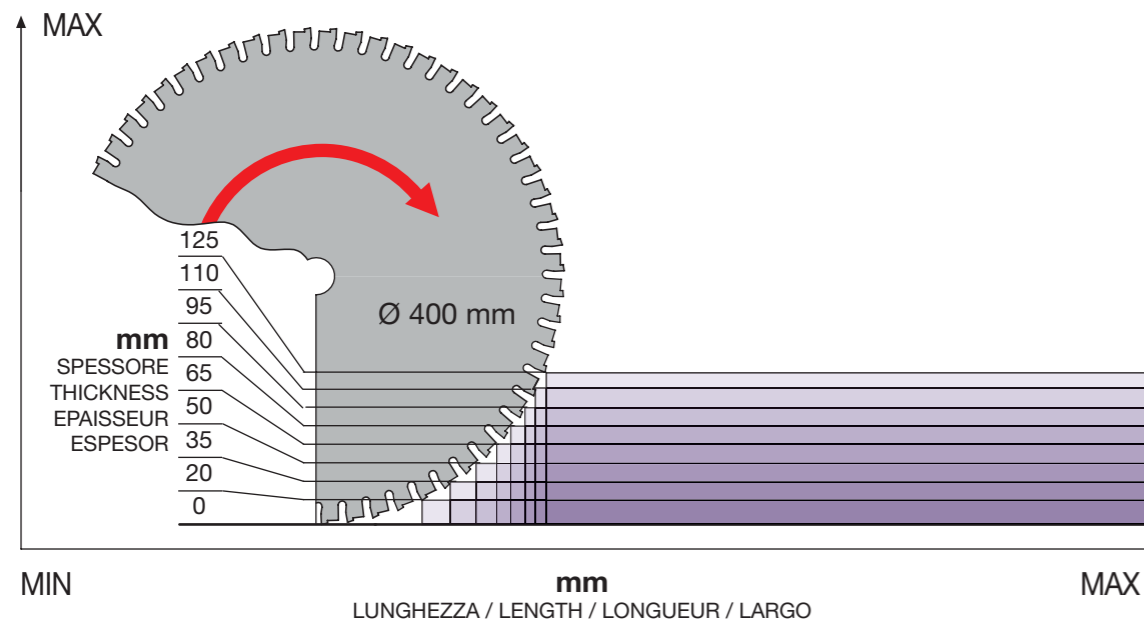

Cutting diagram/Capacité de coupe/Capacidad de corte

LUNGHEZZA / LENGTH / LONGUEUR / LARGO

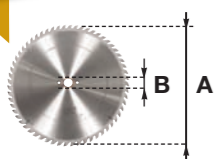

Junior 640			Big 800			Best 960			Best 1250		
90°	45° SX	45° DX	90°	45° SX	45° DX	90°	45° SX	45° DX	90°	45° SX	45° DX
mm	mm	mm	mm	mm	mm	mm	mm	mm	mm	mm	mm
450	125	315	610	240	430	770	350	565	1060	555	745
456			616			776			1066		
464			624			784			1074		
474			634			794			1084		
486			646			806			1096		
501			661			821			1111		
520			680			840			1130		
545	190	380	705	310	500	865	425	615	1155	610	800

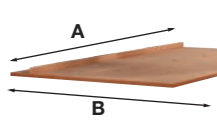
STANDARD VERSION

	Junior 640	Big 800	Best 960	Best 1250
	A Ø 400 mm B Ø 30 mm	A Ø 400 mm B Ø 30 mm	A Ø 400 mm B Ø 30 mm	
	HP 4 kW 3 3PH 2800 RPM	HP 4 kW 3 3PH 2800 RPM	HP 4 kW 3 3PH 2800 RPM	HP 4 kW 3 3PH 2800 RPM
	Ø 60 mm	Ø 60 mm	Ø 60 mm	Ø 60 mm
	A 1100 mm B 880 mm	A 1200 mm B 950 mm	A 1200 mm B 1100 mm	A 2400 mm B 1580 mm
	0 - 860 mm	0 - 1030 mm	0 - 1150 mm	0 - 1440 mm

	Junior 640	Big 800	Best 960	Best 1250
	0 - 45 mm	0 - 45 mm	0-150 mm	0-150 mm
	0 - 80 mm	0 - 80 mm	0 - 80 mm	0 - 80 mm
	A 1550 mm B 1110 mm C 1100 mm D 800 mm	A 1550 mm B 1290 mm C 1200 mm D 800 mm	A 1680 mm B 1560 mm C 1200 mm D 800 mm	A 1680 mm B 1850 mm C 2400 mm D 800 mm
	1420 x 850 x 590 mm 186 kg 198 kg	1420 x 850 x 590 mm 205 kg 217 kg	1500 x 1000 x 600 mm 272 kg 284 kg	2400 x 1050 x 700 mm 325 kg 342 kg



MAGGI TECHNOLOGY

VIA DELLE REGIONI, 297
CERTALDO (FIRENZE) ITALIA . TEL. +39 0571 63541

SERVICE ON LINE



100% QUALITY
MADE IN ITALY

